

Determination of Winding Lumped Parameter Equivalent Circuit by Means of Finite Element Method

Mustapha Toudji¹, Guillaume Parent¹, Stéphane Duchesne¹ and Patrick Dular²

¹Univ. Artois, EA 4025, Laboratoire Systèmes Electrotechniques et Environnement (LSEE), F-62400 Béthune, France

² Department of Electrical Engineering and Computer Science, Montefiore Institute, University of Liège, Liège B-4000, Belgium

In this paper, the finite element method is used in order to determine electrical parameters of a machine winding lumped element model. Thanks to this model, it will be possible to determine the electrical behavior of electrical machine winding fed by a power converter and thus to study the distribution of the turn-to-turn maximum voltage stress as early as the design process. The suitability of the method is validated by comparison with measurements.

Index Terms—Electrical parameters, equivalent circuit, machine windings, finite element analysis.

I. INTRODUCTION

ELECTRICAL machines are more and more driven by power converters. Those converters are based on the use of semiconductor devices which have an increasingly high switching frequency (up to several MHz today). This high frequency can generate sudden voltage and current variations. The latter, when applied to the electrical machine windings, generate high electric field levels between the insulators, exceeding sometimes the Partial Discharge Inception Voltage (PDIV). Exceeding this threshold leads to the appearance of partial discharges which are particularly harmful to the turn-to-turn insulation [1]. For this reason, it is critical to study the PDIV of the machine windings as early as the design process. Therefore, an accurate and not time consuming method which allows to develop an equivalent model of the winding representing all phenomena occurring in the electrical machine winding is required.

Numerous works focus on electrical machines windings modeling methods. The most used ones are based on the transmission line theory [2]–[4], the finite element (FE) method [5]–[7] and lumped parameter equivalent circuits [8]–[10]. The use of the transmission line theory is related to the wavelength at the frequency of the modeled phenomena. It is preferable to use it to model high power electrical machines windings. In addition, this model is no longer valid if a rearrangement of the turns occurs. The FE method has the advantage to be the most accurate one. However, a very fine mesh is needed in order to take into account all phenomena occurring in the winding which makes this method prohibitively time consuming for a design process.

The lumped parameter equivalent circuit method offers the best compromise between accuracy and computation time. There are two approaches: the systemic approach and the phenomenological approach. The systemic approach uses the black box model [11]. The internal structure of the system is thus unknown for the user and moreover its components are not necessarily linked to physical phenomena of machine windings. This approach is suitable for a design process but

has not been chosen in this work. The chosen approach is the phenomenological one which is the most appropriate method for a design process as well as the the most used one. It involves the development of an RLC-lumped parameter equivalent circuit that allows to describe all phenomena occurring in the winding of the electrical machine by representing each specific physical phenomenon by one of its elements. Nevertheless, the determination of the parameter values of the lumped elements model remains problematic since it is generally performed experimentally or with empirical data. This is obviously a step that an electrical designer cannot afford. The aim of this paper is to show that it is possible to compute those values by means of an FE analysis considering both the geometry of the turn and its location in the coil, i.e., lumped parameter values that are specific to each turn, in order to provide a highly scalable tool that allows to predict partial discharges advent during the design process of the machine. Moreover, the results are compared to previous works [10] in order to show the added value for parameters determined by means of an FE analysis.

II. LUMPED PARAMETER EQUIVALENT CIRCUIT

Physical phenomena occurring in an n -turn winding are: generation of Joule losses, iron losses as well as turn-to-turn and turn-to-ground dielectric losses. There are also electrostatic phenomena that create an electric field by turn-to-turn and turn-to-ground charge displacements. Moreover, an electromotive force appears across each turn due to the current flowing through it. In the presented model, each turn of the n -turn winding is modeled using the elementary RLC lumped parameter equivalent cell represented in Fig. 2. It includes the turn resistance R_s representing the Joule losses, the turn-to-turn and the turn-to-ground dielectric losses resistances, respectively noted R_t and R_m , and in presence of an iron core, the resistance R_p representing the core losses. The equivalent cell also includes the self-inductance L_p characterizing the generated electromotive force across the turn and the mutual inductance M_{ij} describing the induced voltage across the j -th turn caused

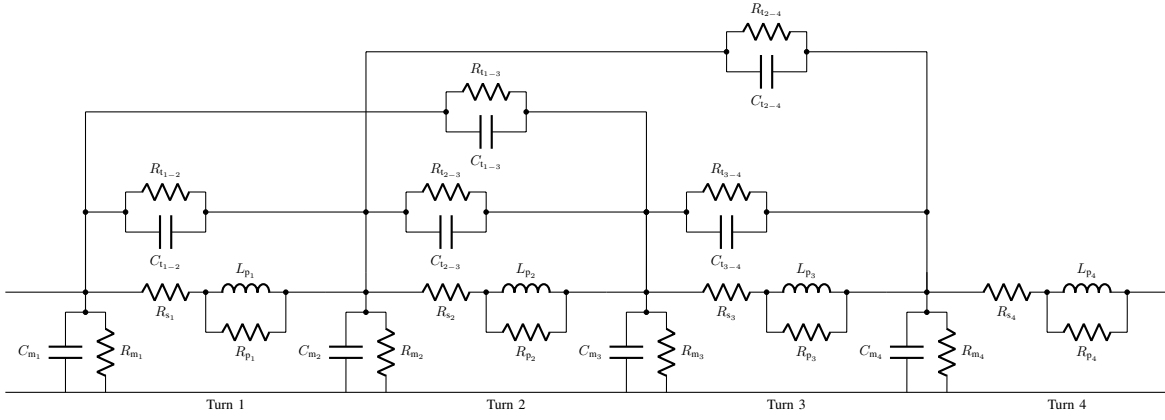

Fig. 1. Lumped parameter equivalent circuit of a 4-turn winding.

by the current flowing through the i -th turn, and thus the generation of an electromotive force across the j -th turn. The model also contains capacitances: the turn-to-turn capacitance C_t and the turn-to-ground capacitance C_m corresponding to the turn-to-turn and turn-to-ground charge displacements, respectively. This model is used to simulate the transient behavior of windings in order to estimate all turn-to-turn voltages. The main purpose is to determine the peak value of the first voltage overshoot which corresponds to the turn-to-turn maximum stress.

As an illustration, the equivalent circuit of the 4-turn winding represented in Fig. 3 is shown in Fig. 1.

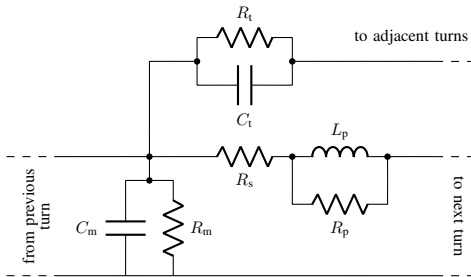

Fig. 2. Lumped parameter equivalent circuit of one turn.

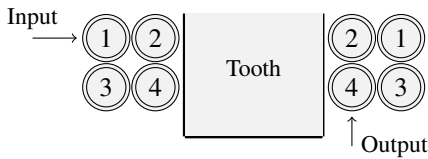

Fig. 3. An example of a 4-turn winding.

III. DETERMINATION OF PARAMETERS

A. Resistances determination

Among the resistances of the equivalent circuit, the self resistance R_{s_i} represents the Joule losses P_i in the i -th turn. They are all determined using a magnetodynamic FE analysis in order to account for both the skin and proximity effects occurring in the winding. The Joule losses in each turn are

$$P_i = \frac{1}{2\sigma} \iint_S \mathbf{J}_i \cdot \mathbf{J}_i^* dS \quad (1)$$

where σ is the electric conductivity [S m^{-1}] and \mathbf{J}_i is the current density inside a cross section of the i -th turn [A m^{-2}]. R_{s_i} can then be evaluated as

$$R_{s_i} = \frac{P_i}{I_i^2} \quad (2)$$

where I_i is the current in the considered turn.

For now, the resistance values representing the turn-to-turn and the turn-to-ground dielectric losses (R_t and R_m) are analytically estimated thanks to previous works [10]. The calculated value is the same in each turn.

The iron losses resistance can be determined by estimating the total iron losses using the approach explained in [12]. In that approach, a specific curve describing iron losses variation according to the magnetic flux density is taken as a reference. After computing the magnetic flux density value in each FE by means of a magnetodynamic FE formulation, the iron losses in that FE can be easily determined using the reference curve. The total iron losses are then the sum of all FE losses.

B. Inductances determination

To calculate the self inductance L_{p_i} of each turn i , a magnetodynamic FE analysis is used. The computation is performed as follows. Each conductor is defined alternately as a current source in which a current of 1 A is imposed while the current flowing through the other conductors is set to 0 A. In a linear case the magnetic energy W_m is

$$W_m = \frac{1}{2\mu} \iint_S \mathbf{B}^2 dS \quad (3)$$

where μ is the magnetic permeability and \mathbf{B} is the magnetic flux density. L_{p_i} can then be evaluated as

$$L_{p_i} = \frac{2 W_m}{I_i^2} \quad (4)$$

The mutual inductance between the i -th and j -th turns is determined following the same methodology, the only

difference being that both the considered turns are defined as current sources at the same time, carrying the same current of 1 A. As for the self inductance determination, the current in the other conductors is set to 0 A. M_{ij} is then defined as

$$M_{ij} = \frac{1}{I_j I_j} (W_m - \frac{1}{2} L_{p_i} I_i^2 - \frac{1}{2} L_{p_j} I_j^2) \quad (5)$$

C. Capacitances determination

The capacitance matrix is computed using an electrostatic FE analysis. Each conductor is defined as a voltage source, set to 1 V, while all other conductors are set to 0 V. The computation allows the determination of the charge q carried by each conductor as well as the global electric energy W_e . The turn-to-turn and turn-to-ground capacitances, C_{i-j} and C_{m_i} respectively, can then be evaluated as

$$C_{i-j} = \frac{q_j}{V_i} ; C_{m_i} = \frac{q_m}{V_i} \quad (6)$$

IV. SIMULATION RESULTS AND VALIDATION

All the computations involved in this work are performed with the academic finite element solver GetDP [13]. It allows to solve usual electromagnetic problems, i.e., electrostatics and magnetodynamics in our case, as well as circuit networks problems. The determination of every parameters presented in section III as well as the simulation of the equivalent circuit are thus solved with the same tool. The whole procedure is applied to the 56-turn winding presented in Fig. 4. These parameter values are reported in Figs. 5, 6 and 7. The coil is tested without its magnetic core in a first approach. Parameters C_m and R_p are therefore neglected.

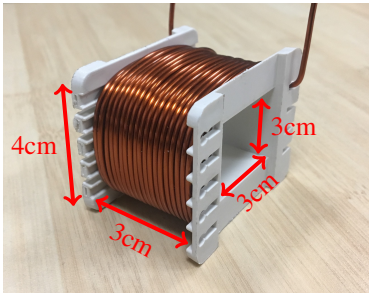

Fig. 4. 56-turn winding.

In the simulation, all the conductors of the winding have the same circle shape with a diameter of 1.5 mm. The coil is supplied with a voltage step of 200 V, lasting 500 ns and with a rising time of 22 ns (Fig. 8). In order to simulate under the same conditions as measurements, an elementary model of a cable has been used. Its different parameters were determined by means of measurements.

Fig. 8 shows comparison between the measured and the simulated step response of the winding. In order to show the impact of the FE parameters determination, the simulation results of the model developed by [10] are added. The parameters of this model were determined using analytical, experimental and numerical methods.

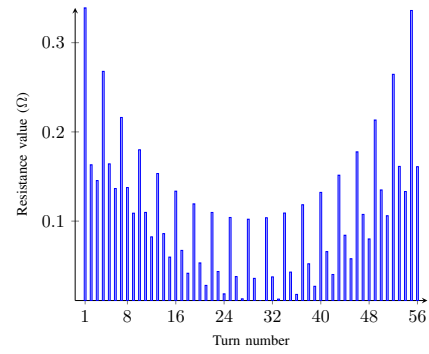

Fig. 5. Values of Joule losses resistances.

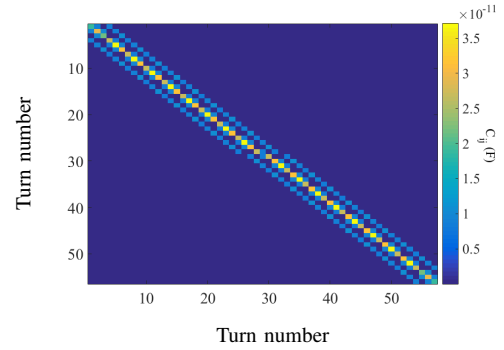

Fig. 6. capacitance matrix.

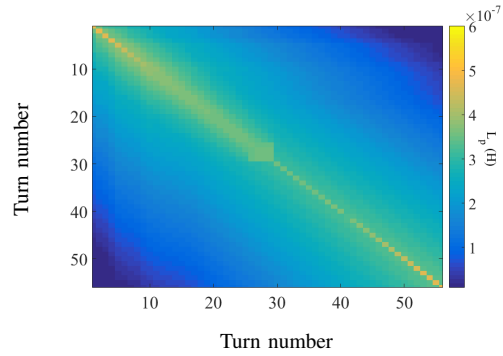

Fig. 7. Inductance matrix.

The impedance variation of the 56-turn winding with respect to the frequency has been measured using the KEYSIGHT Technologies 4294A impedance analyzer and compared to simulation results in a frequency range from 50 Hz to 5 MHz. The comparison also includes simulation results of the model developed by [10] (Fig. 9). Moreover, Table I shows the maximum impedance value with its respective frequency value evaluated with each method.

TABLE I
MAXIMUM IMPEDANCE VALUES VERSUS THE FREQUENCY.

	Maximum impedance (kΩ)	Frequency (MHz)
Developed model	83.3	2.45
Measurement	48.9	2.42
Model from [10]	69.4	3.01

As regards Figs. 8 and 9, the proposed method based on

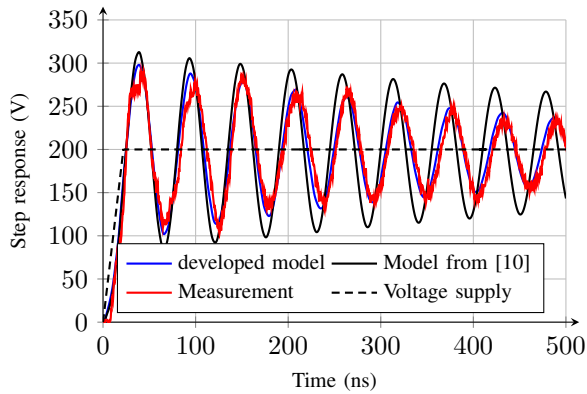

Fig. 8. Measured and simulated voltages at the input of the 56-turn winding.

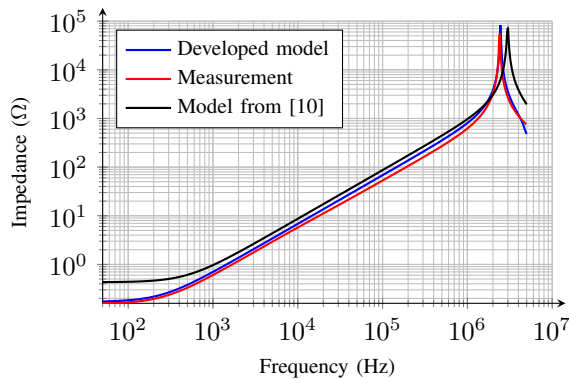

Fig. 9. Measured and simulated impedances of the 56-turn winding.

FE determination of the parameters leads to a very good accordance with measurements, either in time or frequency domain. In comparison with the previous works [10], this study highlights two points. Firstly, it is possible to accurately determine the lumped parameter values *a priori*, i.e., without having to build the winding. As previously stated, this is a key point for the winding designer. Secondly, the results clearly show the importance of considering lumped parameter values specific to each turn instead of using the same elementary cell (Fig. 2) for the whole winding.

V. DISCUSSION

The obtained results on the 56-turn winding validate the different studied assumptions on the physical phenomena occurring in the winding. Of course, the validation has to be confirmed for more complex windings (motors, transformers, etc.) in order to confirm the accuracy of the method. First of all, measurements made with coils placed on a magnetic circuit are needed to fully validate the method with all its parameters. In addition, further works have to be done to make the developed method operational for machines design process.

- The theoretical way used for the dielectric losses determination is probably responsible for the differences observed in the maximum impedance value in the frequency domain. In the time domain, this parameter seems to have a less visible influence.

- It can also be interesting to extend the method bandwidth in order to deal with the other resonance frequencies. Nevertheless, the use of this kind of model is made difficult by the necessity to take into account the wire feeding the coil. Establishing an efficient model for such wires in a large bandwidth is not an easy task. In this way, it would be useful to adapt the bandwidth of our model to the length of the supply wire, which is a critical point.

VI. CONCLUSION

A method has been presented for the *a priori* determination of the elements of an equivalent diagram, which allows the prediction of coils behaviour during a design process. The results show good accuracy in comparison with the measurements and a significant improvement of a previous method using globally defined parameters.

REFERENCES

- [1] M. Kaufhold, G. Borner, M. Eberhardt, and J. Speck, "Failure mechanism of the interturn insulation of low voltage electric machines fed by pulse-controlled inverters," *IEEE Electr. Insul. Mag.*, vol. 12, no. 5, pp. 9–16, Sept 1996.
- [2] S. Islam and G. Ledwich, "An equivalent circuit for calculation of interturn voltage distribution of stator windings in the presence of slot discharges," in *Proceedings of the 5th International Conference on Properties and Applications of Dielectric Materials, 1997.*, vol. 1, May 1997, pp. 507–510 vol.1.
- [3] G. Lupo, C. Petrarca, M. Vitelli, and V. Tucci, "Multiconductor transmission line analysis of steep-front surges in machine windings," *IEEE Trans. Dielectr. Electr. Insul.*, vol. 9, no. 3, pp. 467–478, June 2002.
- [4] H. D. Gersem, O. Henze, T. Weiland, and A. Binder, "Transmission-line modelling of wave propagation effects in machine windings," in *Power Electronics and Motion Control Conference, 2008. EPE-PEMC 2008. 13th*, Sept 2008, pp. 2385–2392.
- [5] B. Vaseghi, B. Nahid-Mobarakeh, N. Takorabet, and F. Meibody-Tabar, "Modeling of non-salient pm synchronous machines under stator winding inter-turn fault condition: dynamic model-fem model," in *2007 IEEE Vehicle Power and Propulsion Conference*, Sept 2007, pp. 635–640.
- [6] V. Venegas, J. L. Guardado, E. Melgoza, and M. Hernandez, "A finite element approach for the calculation of electrical machine parameters at high frequencies," in *Power Engineering Society General Meeting, 2007. IEEE*, June 2007, pp. 1–5.
- [7] G. Suresh, H. A. Toliyat, D. A. Rendusara, and P. N. Enjeti, "Predicting the transient effects of pwm-voltage waveform on the stator windings of random wound induction motors," *IEEE Trans. Power Electron.*, vol. 14, no. 1, pp. 23–30, Jan. 1999.
- [8] O. Magdun, A. Binder, A. Rocks, and O. Henze, "Prediction of common mode ground current in motors of inverter-based drive systems," in *International Aegean Conference on Electrical Machines and Power Electronics, 2007. ACEMP '07.*, Sept 2007, pp. 806–811.
- [9] F. Perisse, P. Werynski, and D. Roger, "A new method for ac machine turn insulation diagnostic based on high frequency resonances," *IEEE Trans. Dielectr. Electr. Insul.*, vol. 14, no. 5, pp. 1308–1315, Oct. 2007.
- [10] V. Mihaila, S. Duchesne, and D. Roger, "A simulation method to predict the turn-to-turn voltage spikes in a pwm-fed motor winding," *IEEE Trans. Dielectr. Electr. Insul.*, vol. 18, no. 5, pp. 1609–1615, 2011.
- [11] Y. Liu, S. A. Sebo, R. Caldecott, D. G. Kasten, and S. E. Wright, "Modeling of converter transformers using frequency domain terminal impedance measurements," *IEEE Trans. Power Del.*, vol. 8, no. 1, pp. 66–72, Jan. 1993.
- [12] O. Bottauscio, A. Canova, M. Chiampi, and M. Repetto, "Iron losses in electrical machines: influence of different material models," *IEEE Trans. Magn.*, vol. 38, no. 2, pp. 805–808, Mar. 2002.
- [13] P. Dular, C. Geuzaine, F. Henrotte, and W. Legros, "A general environment for the treatment of discrete problems and its application to the finite element method," *IEEE Trans. Magn.*, vol. 34, no. 5, pp. 3395–3398, Sept 1998.